

Round Air Bearing 123 mm

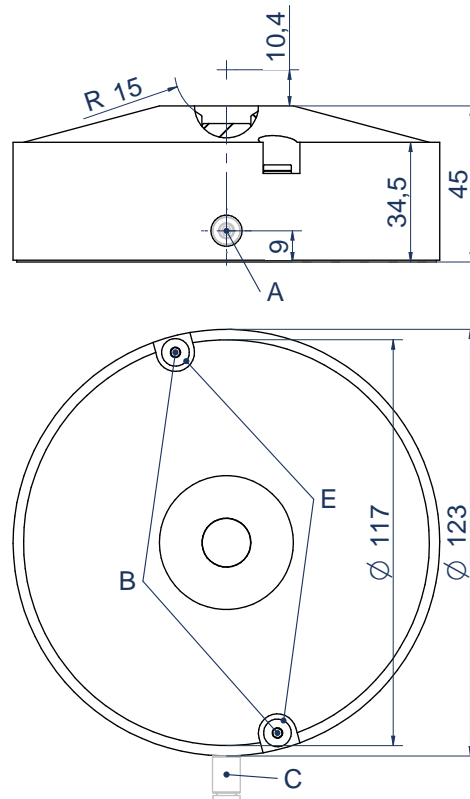
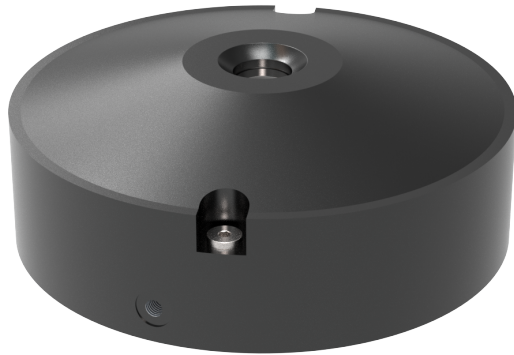

Technical Specifications

Article name	RD-123S1
Nominal pressure	5 bar
Maximum pressure	6.5 bar
Nominal load	3151 N
Nominal air gap	6 μm
Nominal stiffness	264 N/ μm
Air consumption	3.4 l _s /min
Maximum air consumption	7 l _s /min
Air connectors	M5
Weight	1.17 kg
Housing material	EN AW-6082 anodized
Technology	Graphite
Mounting geometry	Ø 30 mm

- A Compressed air connection (M5)
- B Vacuum connection (M5, non-functional)
- C Push-in fitting QSM-M5-4-I-R (not included)
- E Blind plug B-M5-B (preassembled)

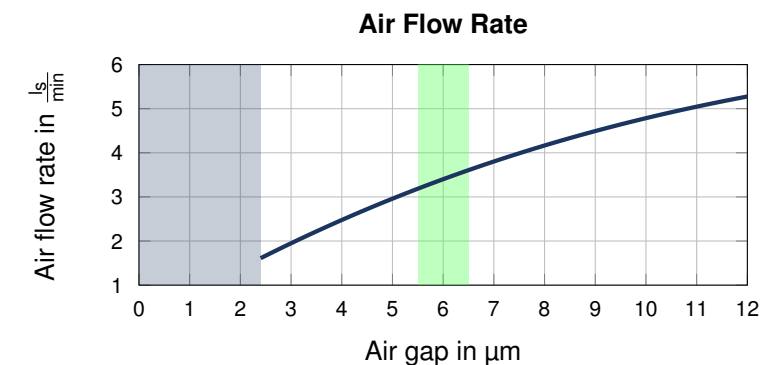
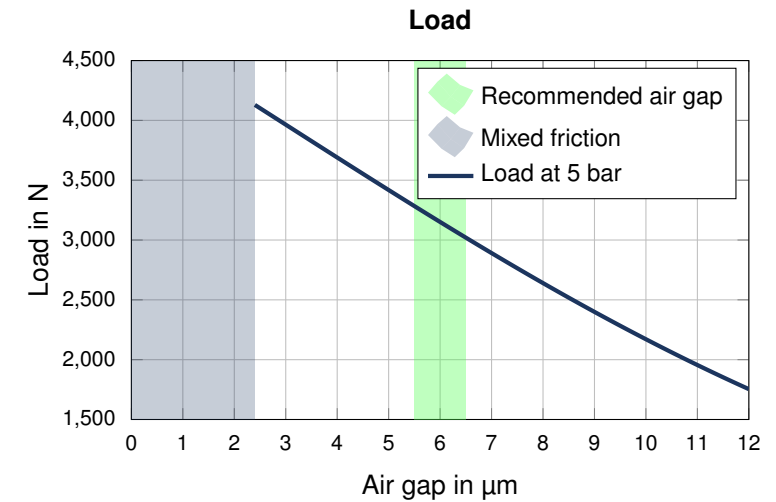

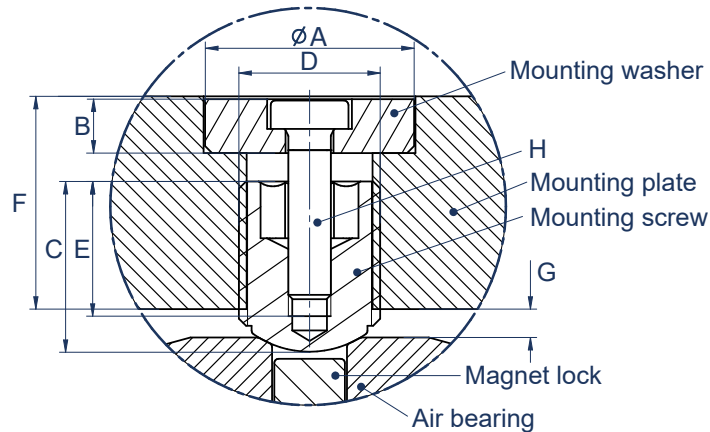

Description	Variable	Value	Article name
Diameter mounting washer	A	38.6 ⁺⁰ _{-0.1} mm	MW-40x6
Height mounting washer	B	5.8 ⁺⁰ _{-0.05} mm	
Recommended mounting screw	C	25 mm	MS-M24x1-L25 ¹
Thread length mounting screw	D	M24x1	
Length counter thread	E	19 mm	
Recommended thickness mounting plate	F	30 mm	
Recommended distance air bearing	G	2 mm	
Lock screw DIN 7984	H	M5	

¹ Other standard lengths are available, custom length on request

Installation and Usage

The detailed illustration above shows the recommended installation of the air bearing including securing the mounting screw with a lock screw and washer. An alternative installation, for example with a lock nut, is permitted.

When handling the air bearings, always ensure that they are clean. In particular, ferromagnetic chips and particles must be avoided in the vicinity of the air bearing due to the magnetic locking mechanism. Before installation, the air bearing and the counter surface must be thoroughly cleaned, using only isopropyl alcohol and lint-free cleaning cloths for the air bearing.

The air supply to the bearings must meet particle size class 2 (max. 1 µm), pressure dew point class 4 (max. +3 °C) and oil content class 2 (max. 0.1 mg/m³) in accordance with DIN ISO 8573-1.

Counter Surface and Friction

The friction-free use of the air bearings depends crucially on the quality of the counter surface. IMG air bearings are tested against a granite plate of grade 000 in accordance with DIN 876.

Alternative materials for the counter surface are e.g. coated aluminum, glass, steel, or ceramic, provided that both the roughness depth and flatness in the movement range of the air bearing are less than 2 µm.

Mixed or sliding friction can occur with loads greater than the nominal load capacity, uneven counter surfaces, or too little supply pressure. In these cases, the air bearing should not be moved, even if the air bearings have emergency usage properties due to the graphite surface.

General

The air bearings are delivered individually packaged. The scope of delivery includes any blind plugs that may be required. We can supply you with the following accessories and services on request:

- push-in fittings
- mounting screws
- mounting accessories
- test report
- comparative vibration test
- lint-free cleaning cloths

Special designs of air bearings and complete drive solutions based on air bearings are also available from us.

Discover our complete range of air bearings at www.img-ilmenau.de/en/air-bearings or feel free to contact us.